

温馨提示：
盘面输出转速高于30rpm/min.请订货前说明.

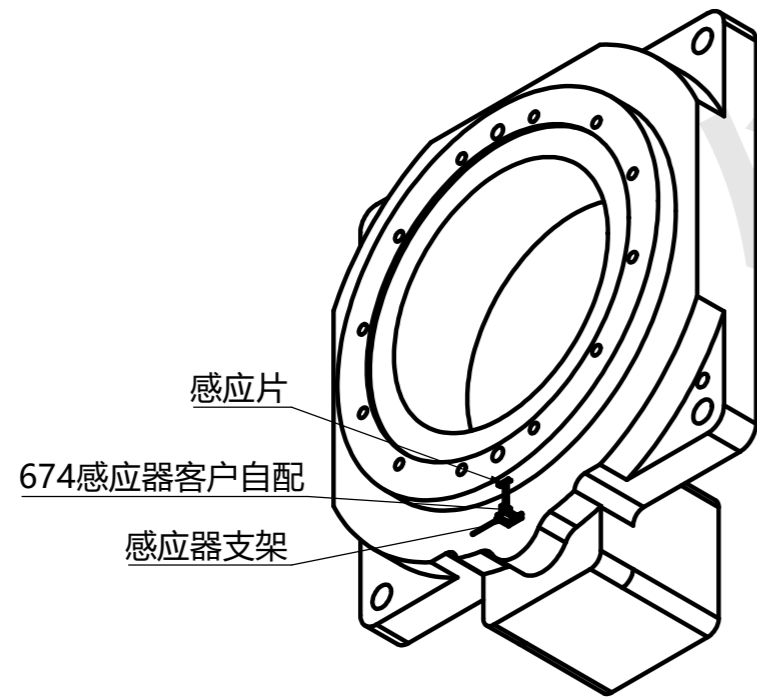

技术参数	规格型号		
	GT680-C-10 55-160-215-M14		
旋转平台轴承	交叉滚子轴承		
减速比 i	1: 10(不含减速机)	容许轴向压力 N	40000
容许输入转矩 N.m	≤300	旋转平台平面度 mm	0.03
容许盘面转速 rpm	30	旋转平台同心度 mm	0.03
重复定位精度 arc-sec	±20	精度寿命 hr	20000(间歇运转)
定位精度 arc-sec	±40	保护等级 IP	40

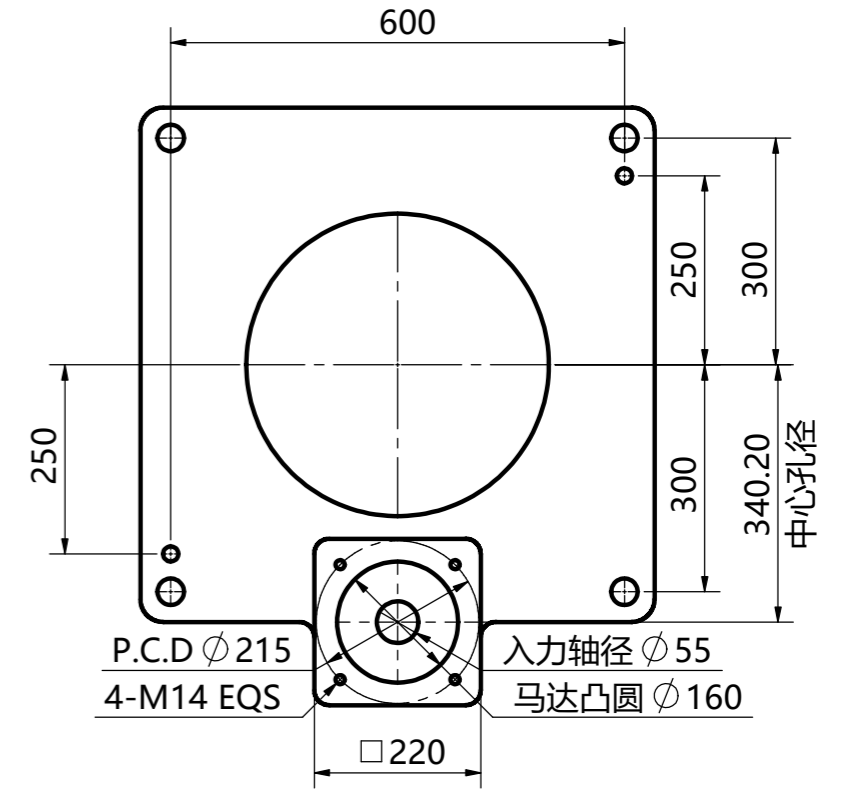
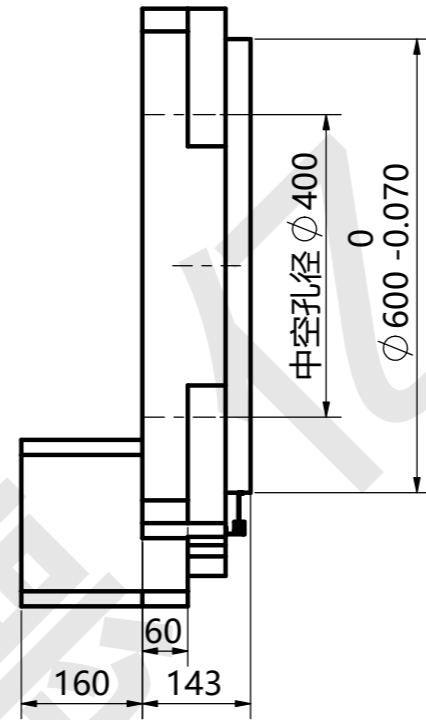
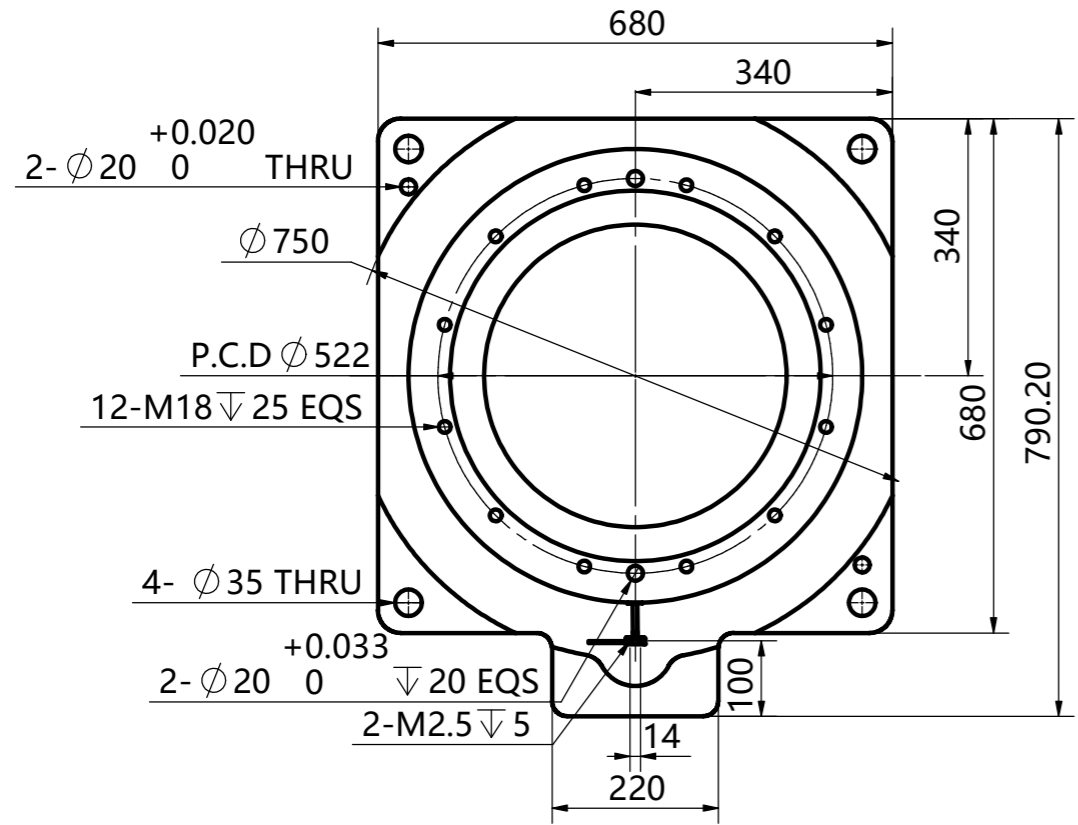